

2.4GHz RF HI-GAIN ANTENNA

ITEM No : 1YG-2418

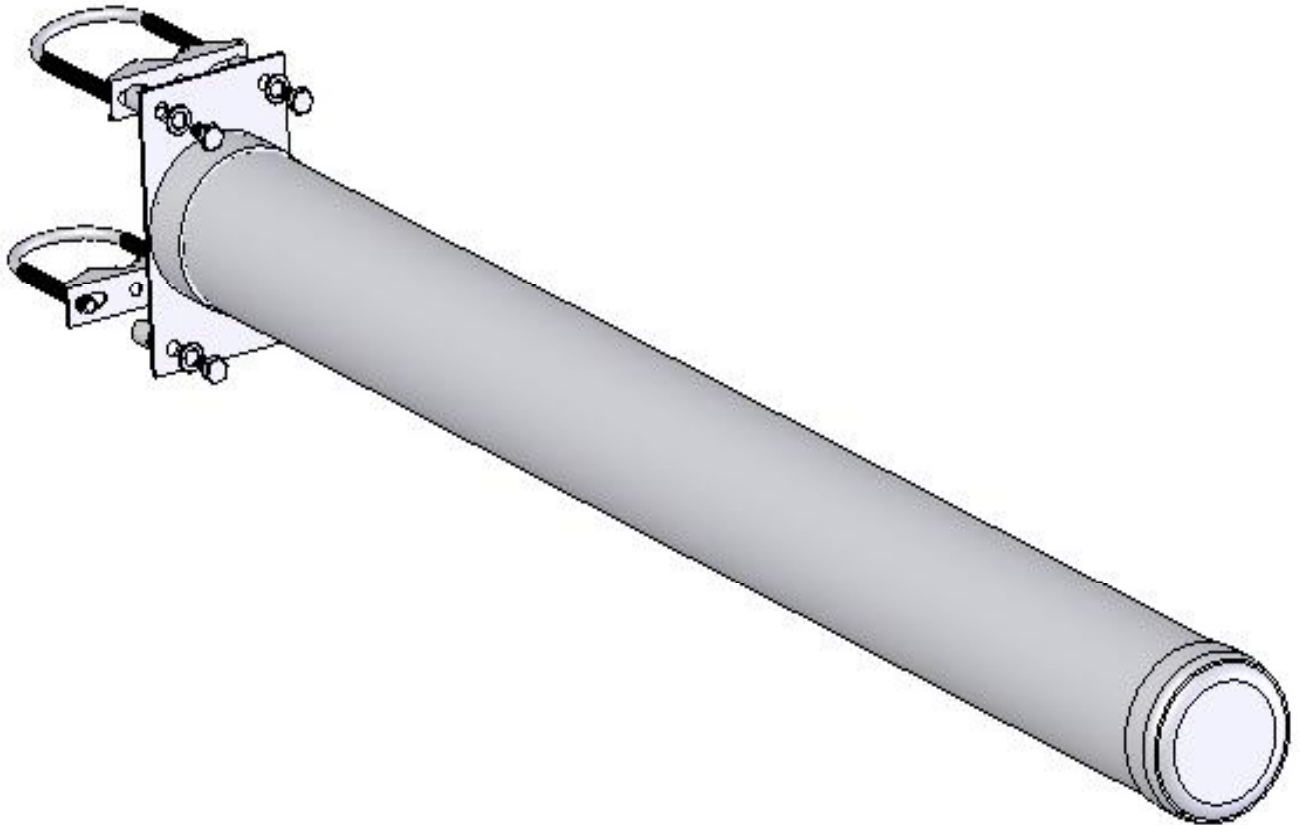

※ SPECIFICATION

- Frequency: 2400~2500 MHz
- Max gain: 18dBi
- Connector: N female
- Max input power: 15W
- Wave impedance: 50 OHMS $\pm 5 \Omega$
- dimensions: $\varnothing 75 \times 900$ mm
- Weight: 800g
- For image/Data/Voice communication and Wireless LAN system