

5.0GHz RF HI-GAIN ANTENNA

ITEM NO : 1GP-5009

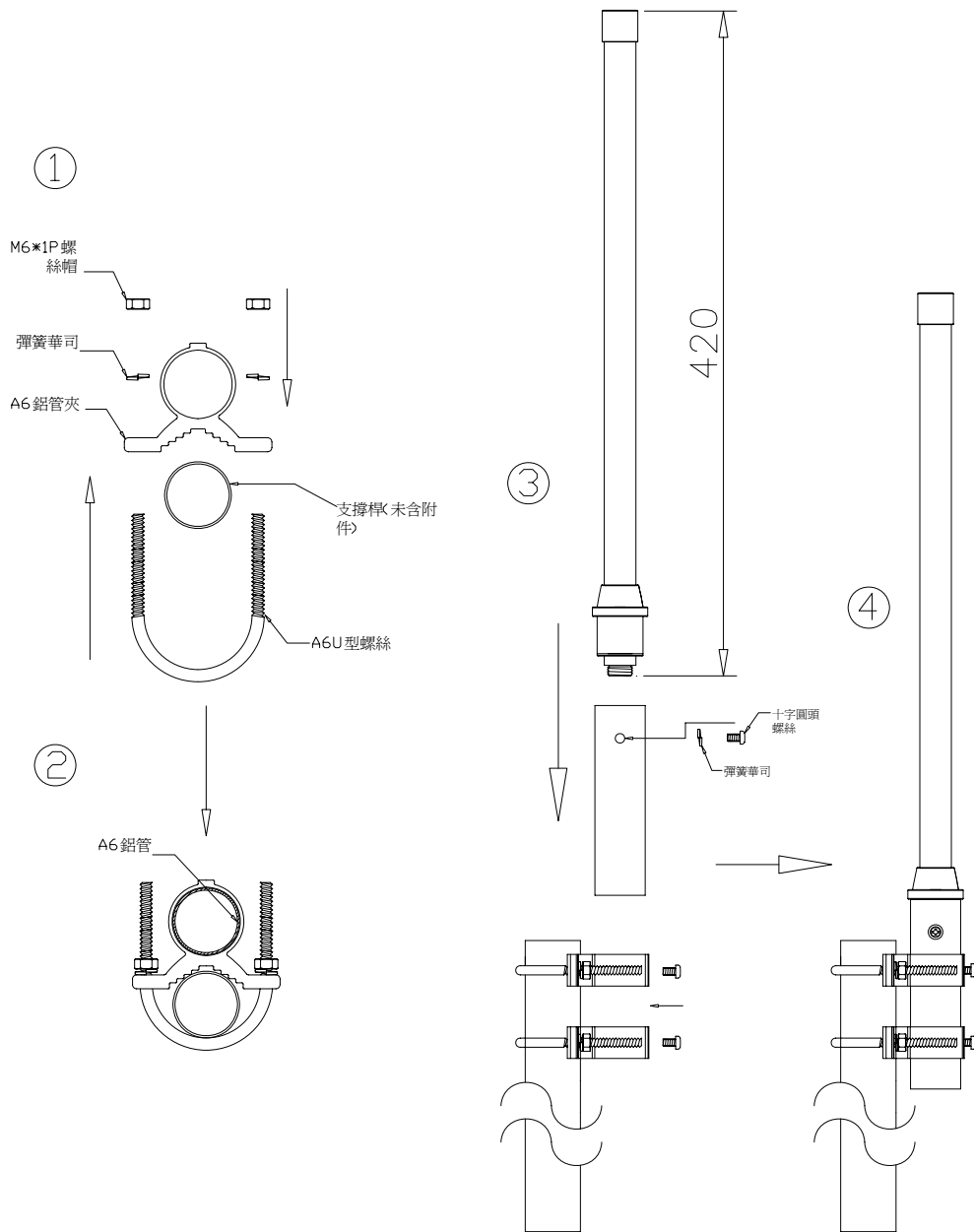

※ SPECIFICATION

- Frequency: 4900~5100MHz
- Max gain: 9 dBi
- Connector: N female
- Max input power: 50W
- Wave impedance: 50 ohm
- Dimensions: 420 mm
- Weight: 430 g
- For Image/Data/Voice communications and Wireless LAN system